

# *vargokal SIF*

## HOUSE SEWAGE SYSTEM - SYPHONS

WALL AND FLOOR SYPHONS FOR WATER DRAINAGE

Technology  
and tradition.

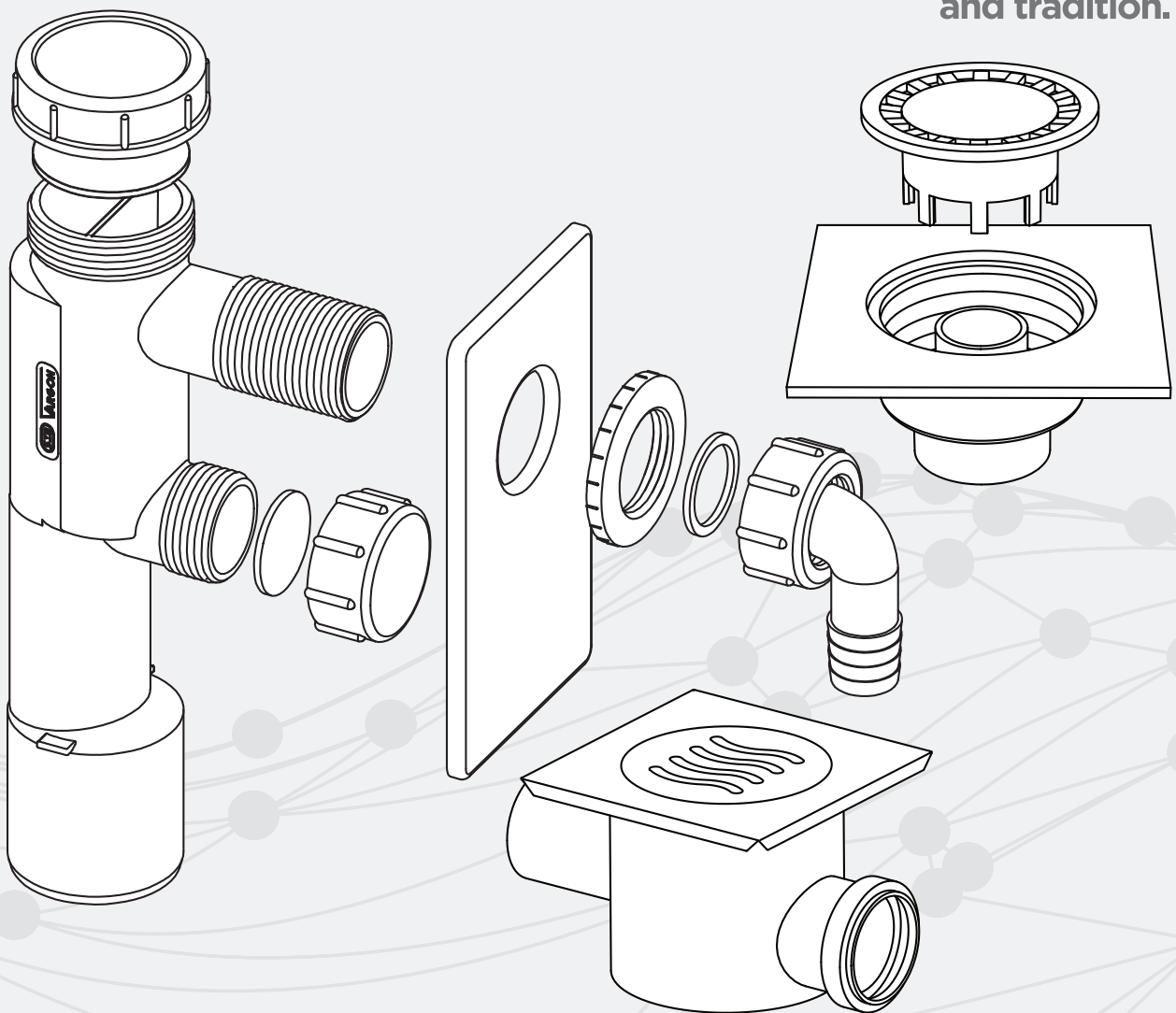

**CATALOGUE 08/2022**

Complete solutions for  
**sewage, water / gas supply,  
drainage and cable protection**

**SVB** **VARGON**  
INSTALLATION SYSTEMS



Europe



# *vargokal SIF*

**SEWAGE**

**SYPHONS**

## Description and purpose



In addition to *vargokal* and *vargokal PLUS* installation systems, we also offer a line of innovative wall and floor syphons that meet all requirements and types of installations, united under the common name *vargokal SIF*.

*vargokal SIF* range of wall and floor syphons also includes a series of grids with an attractive and innovative design and an anti-odor insert for floor syphons.

The floor syphons come with INOX magnetic and non-magnetic grids with dimensions 140 x 140 mm, and are connected to a Ø50 diameter pipe. The non-magnetic INOX used for the production of gratings is classified as AISI 304, i.e. as stainless steel with a thickness of 6 mm of exceptional strength, while the magnetic INOX has the classification AISI 430 and is of the same thickness and strength. Floor syphons are extremely easy to maintain and clean, they are an ideal solution for draining water and liquids in bathrooms and on floors for the construction and food industry, ensuring the best hygiene conditions fully compliant with regulations.



In order to remove unpleasant odors from the drain, the best solution comes in the form of an anti-odour insert for the floor syphon. The most common problem in bathrooms is the unpleasant odor that spreads from an improperly installed floor syphon. The basic purpose of the anti-odor insert is to prevent unpleasant odors that pass through the syphon grid and the return of sanitary water in the bathrooms. In a dry syphon, water does not stand still, the lid does not allow odors to pass through and allows water to pass through unhindered. An anti-odor insert can be installed in a few simple steps. It is necessary to remove the originally installed sleeve from the existing floor syphon (drain) and install an anti-odor insert in its place. The anti-odor insert works like a non-return valve and is easy to install. It fits in 99% of floor drains installed in the bathroom.



## Product packaging

*vargokal SIF* products are packed individually in bags and then in boxes for easier handling, storage and transport.



Immediately after production, the products are packed in the original factory packaging, i.e. bags and then in appropriate boxes. The boxes are then stacked on a pallet and are ready for delivery to end customers.



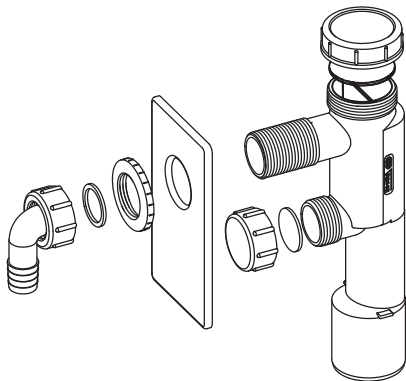

# SYPHONS

|  |                |             |   |   |
|--|----------------|-------------|---|---|
| Art. 901<br><b>WASHING MACHINE AND DISHWASHER SYPHON</b> | <b>DN</b>      | <b>Code</b> |  |  |
|  | <b>50 / 40</b> | 22031       | <b>40</b>   | <b>320</b>  |



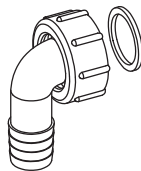

|   |                |             |   |   |
|---|----------------|-------------|---|---|
| Art. 901 / 1<br><b>SYPHON CONNECTION</b><br><i>for Art. 901</i> | <b>DN</b>      | <b>Code</b> |  |  |
|   | <b>21 / 23</b> | 22032       | <b>30</b>   | <b>3000</b>   |

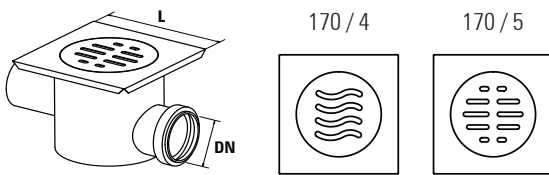

|   |           |          |                 |   |   |
|---|-----------|----------|-----------------|---|---|
| Art. 170<br><b>FLOOR SYPHON 2/1 - HORIZONTAL</b><br><i>inox grid and sleeve</i> | <b>DN</b> | <b>L</b> | <b>Code</b>     |  |  |
|   | <b>50</b> | 140      | (170 / 4) 19329 | <b>20</b>   | <b>240</b>  |
|   | <b>50</b> | 140      | (170 / 5) 19331 | <b>20</b>   | <b>240</b>  |



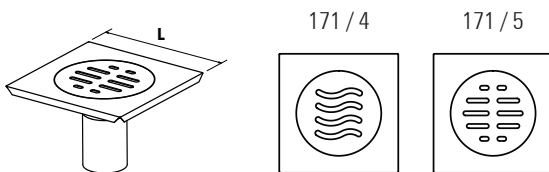

|  |            |                 |   |   |
|--|------------|-----------------|---|---|
| Art. 171<br><b>GRID WITH SPOUT FOR FLOOR SYPHON</b><br><i>inox</i> | <b>L</b>   | <b>Code</b>     |  |  |
|  | <b>140</b> | (171 / 4) 19330 | <b>30</b>   | <b>720</b>  |
|  | <b>140</b> | (171 / 5) 19332 | <b>30</b>   | <b>720</b>  |

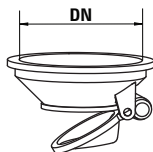

| ANTI-ODOR INSERT FOR FLOOR SYPHON | DN          | Code      |  |
|-----------------------------------|-------------|-----------|---|
|                                   | <b>83,5</b> | – 21593 – | 20 / <b>10</b>  |



| Art. 175<br>FLOOR DRAIN - VERTICAL<br><i>outer socket</i> | DN         | L   | Code     |  |  |
|---|------------|-----|----------|---|---|
|   | <b>40</b>  | 100 | – 1768 – | <b>12</b>   | -   |
|   | <b>50</b>  | 100 | – 1769 – | <b>12</b>   | -   |
|   | <b>50</b>  | 150 | – 1770 – | <b>12</b>   | -   |
|   | <b>50</b>  | 200 | – 1773 – | <b>12</b>   | -   |
|   | <b>75</b>  | 200 | 1774     | <b>6</b>  | 144   |
|   | <b>75</b>  | 250 | 1779     | <b>6</b>  | 72  |
|   | <b>75</b>  | 300 | 1784     | <b>6</b>  | 72  |
|   | <b>110</b> | 200 | 1772     | <b>8</b>  | 144   |
|   | <b>110</b> | 250 | 1778     | <b>6</b>  | 72  |
|   | <b>110</b> | 300 | 1783     | <b>6</b>  | 72  |

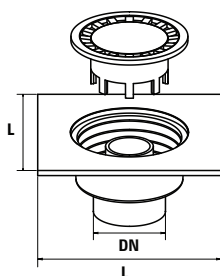

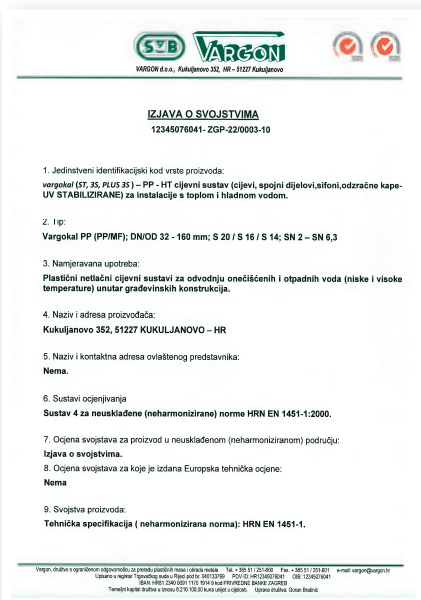

*vargokal*

HOUSE SEWAGE SYSTEM

*vargokal PLUS*

HOUSE SEWAGE SYSTEM - LOW NOISE

*vargokal ULTRA*

HOUSE SEWAGE SYSTEM - SILENT

*vargokal SIF*

HOUSE SEWAGE SYSTEM - SYPHONS

*vargoterm*

HOUSE WATER SUPPLY

*vargoplen*

WATER

*vargoplen*

IRRIGATION AND SEWAGE

*vargoplen*

GAS

*vargokor*

SEWAGE PIPES

*vargokor*

SEWAGE CHAMBERS AND CATCHPITS

*vargodren*

DRAINAGE PIPES

*vargotect*

CABLE PROTECTION PIPES

*vargoheat*

FLOOR HEATING PIPES

Local distributor:

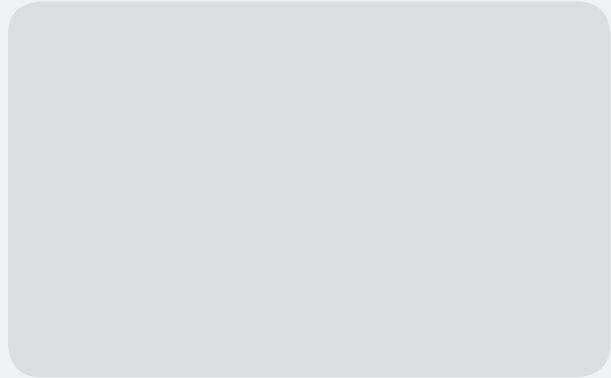

Find us on:



☎ 00385 (0)51 251 800

☎ 00385 (0)51 251 801

✉ info@vargon.hr

📍 Kukuljanovo 352, 51227 Kukuljanovo, Croatia

🌐 [www.vargon.hr](http://www.vargon.hr)